

环保物料

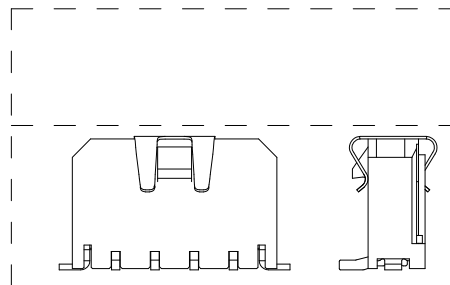

Specifications:

Contact resistance:  $\leq 20\text{m}\Omega$   
 Insulation resistance:  $\geq 1000\text{M}\Omega$   
 Rated voltage: 250V AC DC  
 Rated current: 5.0A AC DC  
 Withstand Voltage: 1000V AC/minute  
 Temperature Range:  $-25^{\circ}\text{C} \sim +85^{\circ}\text{C}$   
 Housing: LCP UL94V-0, BLACK  
 Contacts: Brass/MATTE Sn-plated  
 Solder Tabs: Brass/MATTE Sn-plated  
 CAP: Stainless steel

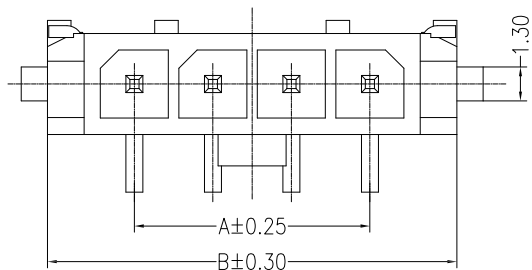
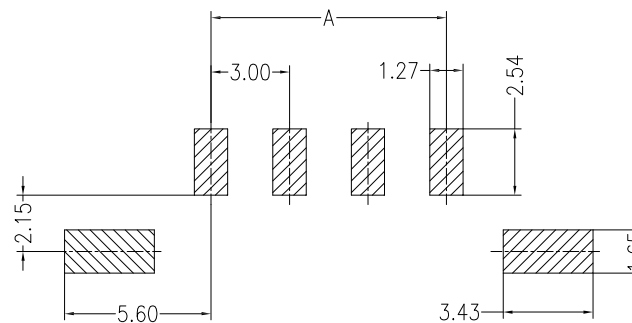
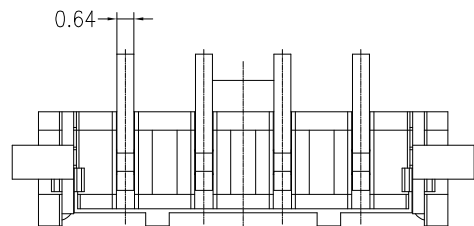
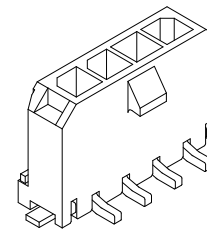
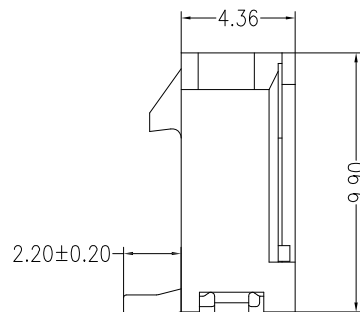
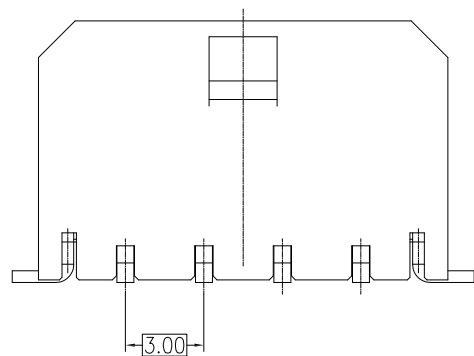

PIN	DIM A	DIM B
2	3.00	9.65
3	6.00	12.65
4	9.00	15.65
5	12.00	18.65
6	15.00	21.65
7	18.00	24.65
8	21.00	27.65
9	24.00	30.65
10	27.00	33.65
11	30.00	36.65
12	33.00	39.65

				GENERAL TOLERANCES		SCALE: 1:1	NAME	DATE	康导新能源 网址: www.dgonne.com 电话: 0769-85337833 邮箱: 2850178986@qq.com 传真: 0769-85392827	PART. NO: 23001AWV	
				LINEAR	ANGLES	APPROVED	黎腾	2017.06.16		DWG. NO:	
A0	新图面发行	2017.06.16	UNIT: MM	0.00±0.25	X° ±3°	DESIGNER	肖坤权	2017.06.16	TITLE: 3.00mmPITCH 180° WAFER SMT TYPE		REV: A0
REV.	REVISION RECORD	DATE	SIZE: A4	0.000±0.15	X° X'±2°	DRAWN	旷淇	2017.06.16			SHEET: 1/1