

环保物料

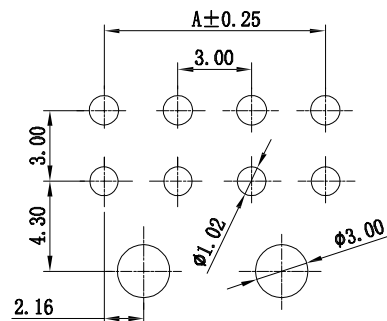

8P~24P P.C.B LAYOUT

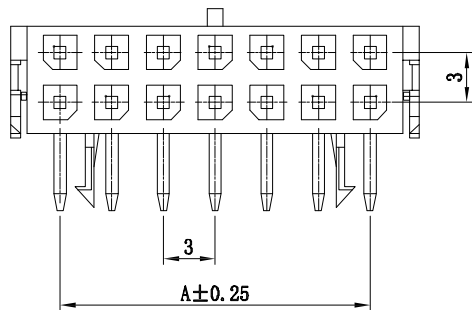
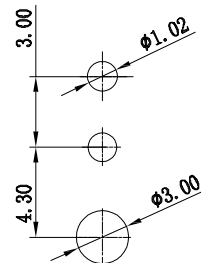

2P P.C.B LAYOUT

Specifications:

Contact resistance:  $\leq 20m\Omega$   
 Insulation resistance:  $\geq 1000M\Omega$   
 Rated voltage: 250V AC DC  
 Rated current: 5.0A AC DC  
 Withstand Voltage: 1000V AC/minute  
 Temperature Range:  $-25^{\circ}C \sim +85^{\circ}C$   
 Housing: PA46 UL94V-0, BLACK  
 Contacts: Brass/Sn-plated

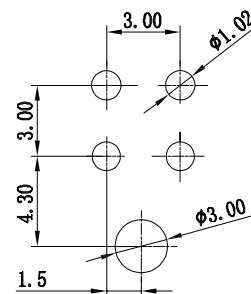
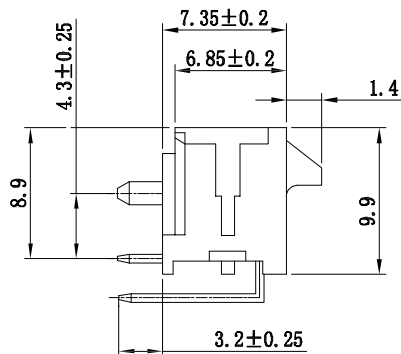
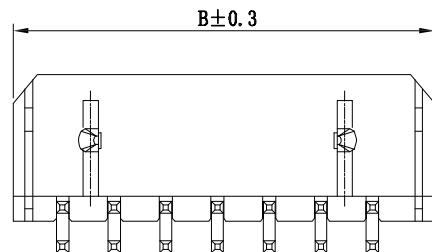
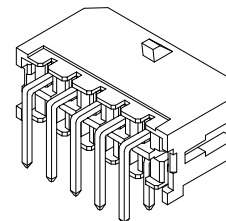

4P~6P P.C.B LAYOUT

Poles	Dimensions mm	
	A	B
2	--	6.65
4	3.00	9.65
6	6.00	12.65
8	9.00	15.65
10	12.00	18.65
12	15.00	21.65
14	18.00	24.65
16	21.00	27.65
18	24.00	30.65
20	27.00	33.65
22	30.00	36.65
24	33.00	39.65

		GENERAL TOLERANCES		SCALE:	NAME	DATE	康导新能源 网址: www.dgconne.com 电话: 0789-85337633 邮箱: 2850175988@qq.com 传真: 0789-85392827	PART. NO:	
		LINEAR		1:1	黎腾	2017.06.16		23002AW	
		ANGLES		APPROVED	肖坤权	2017.06.16		DWG. NO:	
A0	新图面发行	2017.06.16	UNIT: MM	DESIGNER	旷淇	2017.06.16		REV: A0 SHEET: 1/1	
REV.	REVISION RECORD	DATE	SIZE: A4	DRAWN	TITLE:			3.00mmPITCH 90° WAFER SMT TYPE	
1	2	3	4	5	6	7	8		